

Console



Easy monitoring of the process using the thermocouple (type K).

JBC offers **3 preset temperature profiles** and **25 additional user-defined profiles** to suit all your needs.

The control thermocouple is used to precisely follow the temperature profile while auxiliary thermocouples can be used to protect the components.

Safer and more efficient rework

1 Power Mode allows working at a fixed power level with the option of using a protection thermocouple.

2 Temperature Mode keeps the PCBA at a selected temperature, using the regulation or protection TC.

3 Profile Mode allows control of the heating rate of the PCBA by the use of a control and a protection thermocouple.

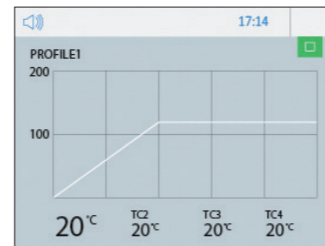
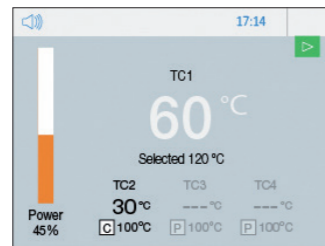
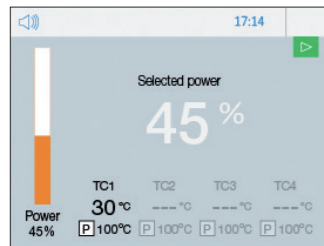

PCB Support

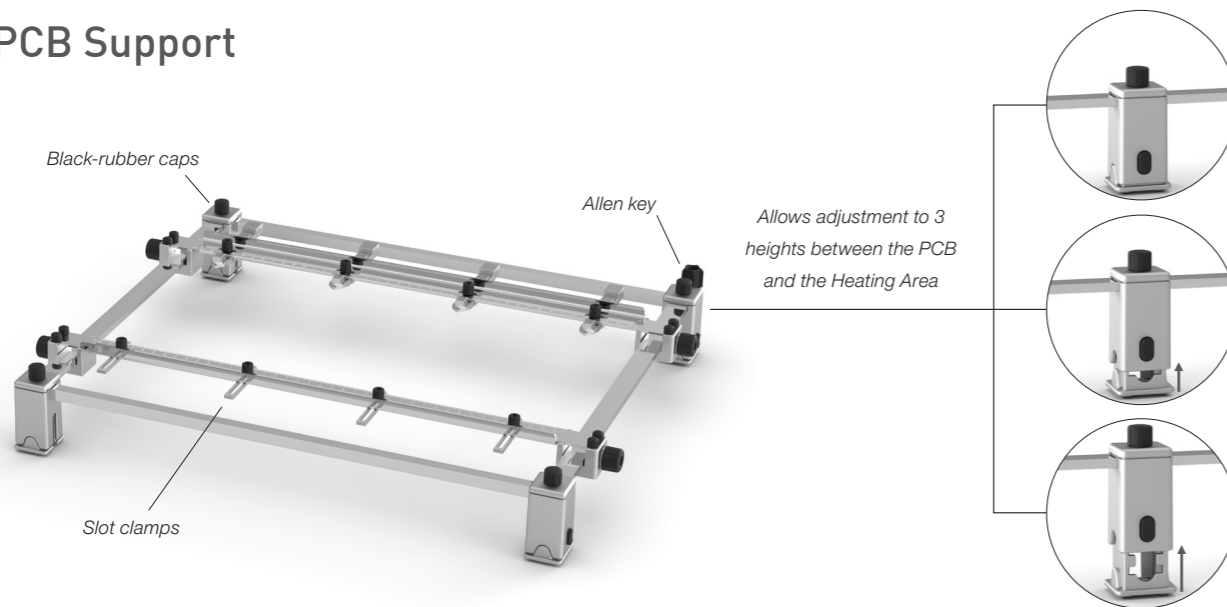

The support allows you to properly position PCBs of the same batch so as to always heat the same area. It is ideal for repetitive soldering jobs which means saving time and optimizing workflow.

PCB Support references: **PSN, PSS, PSB** and **PSX**.

ESD safe

www.jbctools.com



0028255/1121



PCB Preheaters

Reduce the risk of thermal shock while reworking

PCB Preheaters

- **Matchless reliability in temperature accuracy and control** of the PCBA so that no component is damaged.
- **3 Work Modes** (Power, Temperature, Profile) **safer and easier** with up to 8 thermocouples.
- **2 independent work zones** to be turned on/off.

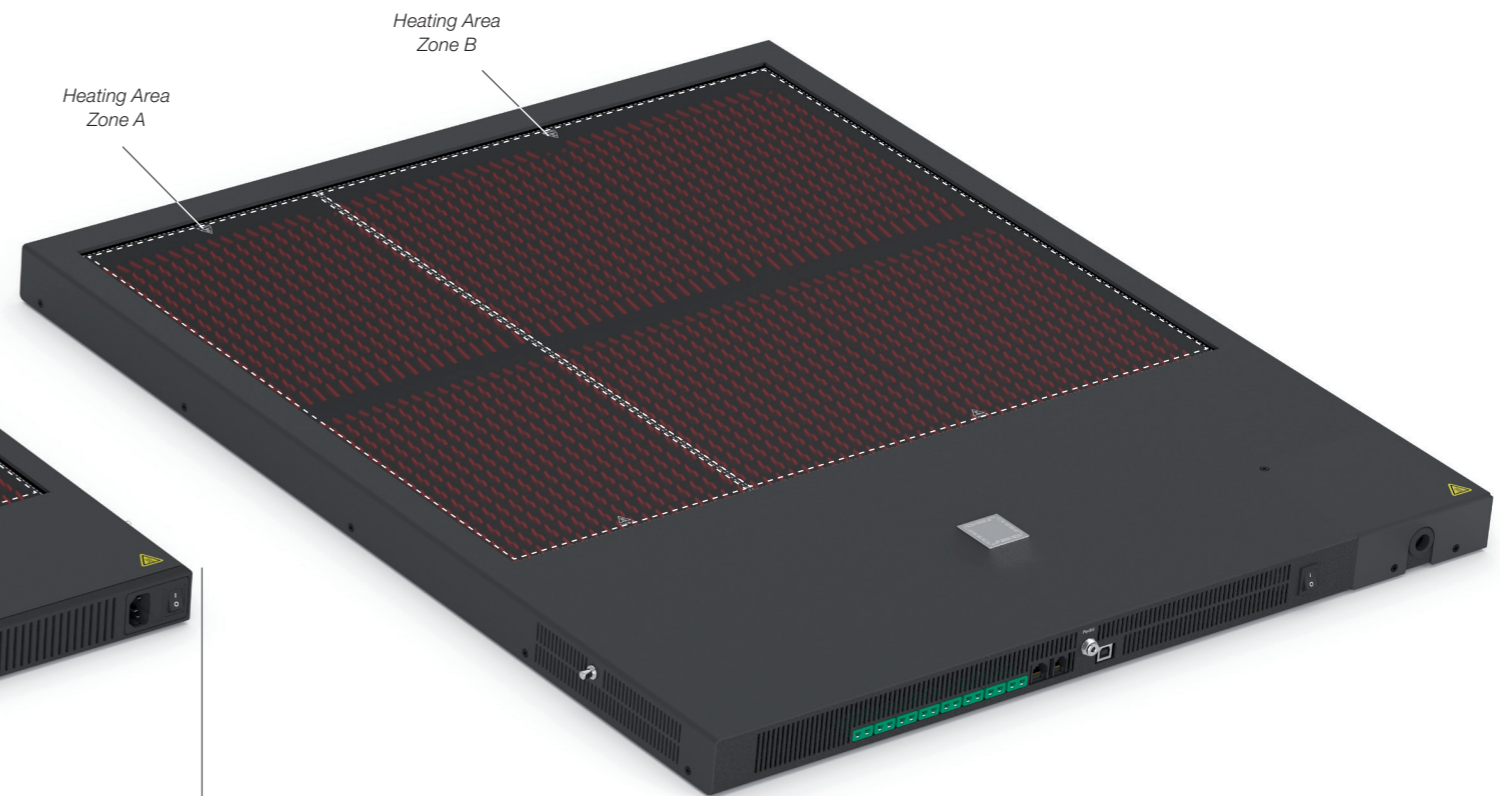
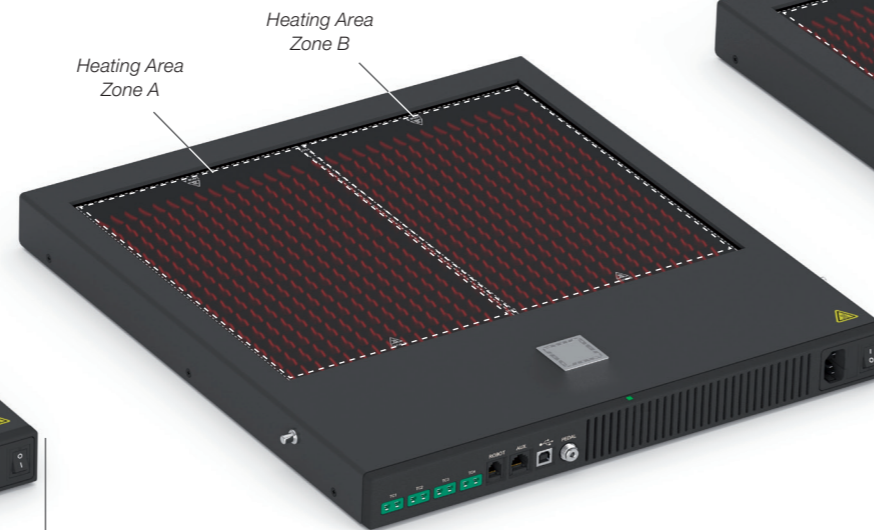
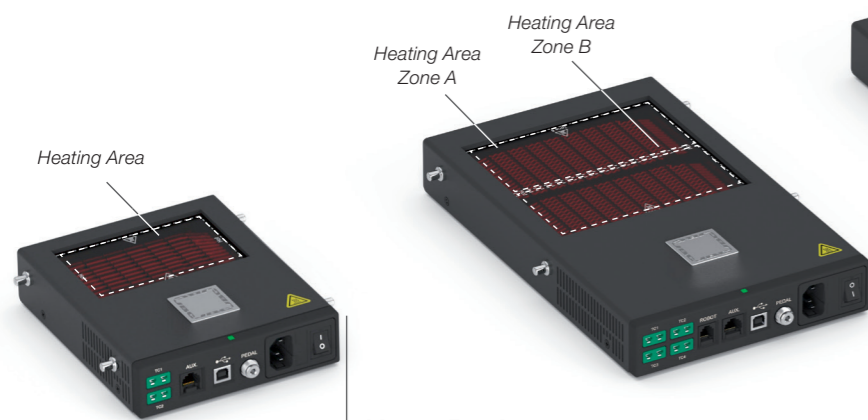

Nano Preheater

PHNK (Preheater Set reference)

Max. Heating Area: 108 x 70 mm
4.25 x 2.75 in
Nominal power: 300 W
Thermocouples: x2
Dimensions: 179 x 165 x 41.5 mm
7.04 x 6.5 x 1.63 in
Weight: 1.2 Kg
2.6 lb

Small Preheater

PHSK (Preheater Set reference)

Max. Heating Area: 130 x 135 mm
(Zone A+B) 5.12 x 5.31 in
Nominal power: 500 W
Thermocouples: x4
Dimensions: 195 x 288 x 41.5 mm
7.68 x 11.34 x 1.63 in
Weight: 2.8 Kg
6.17 lb

Large Preheater

PHBK (Preheater Set reference)

Max. Heating Area: 360 x 277 mm
(Zone A+B) 14.2 x 10.9 in
Nominal power: 1800 W
Thermocouple: x4
Dimensions: 426 x 444 x 41 mm
16.80 x 17.5 x 1.6 in
Weight: 6.9 Kg
15.4 lb

XL Preheater

PHXK (Preheater Set reference)

Max. Heating Area: 510 x 610 mm
(Zone A+B) 20 x 24 in
Nominal power: 5400 W
Thermocouple: x8
Dimensions: 790 x 664 x 42 mm
31.1 x 26.1 x 1.65 in
Weight: 18 Kg
39.7 lb

Preheater Set

Complete system for preheating multilayer PCBs, ideal for repetitive soldering jobs. It includes: **Heater Unit, Console, Support, PH218 Thermocouple Type K and PH217 Kapton Tape.**



XL Preheater Set also includes **three metallic supports of different heights** for preventing PCB bending due to large dimensions.



Connections

By means of **JBC Software** (available on www.jbctools.com), JBC Preheater can be synchronized with other JBC Hot Air and/or Soldering Stations as well as JBC Fume Extractor equipment in order for them to work jointly and to perform your rework process optimally.

